



**PANASONIC SPOT INCASTRAT LED 12W LUMINA CALDA 3000K DECUPARE**  
**155X155MM 850LM**

Spot incastrat cu LED

Ideal pentru montaj in tavane false.

Estrem de plat cu o lumina foarte eficienta.

Tensiune de alimentare 230V

Unghi de dispersie 120 grade

Grad de protectie IP20

Clasa energetica A+++

Putere 12W

Flux Luminos 850lm

Temperatura de culoare 3000K

Dimensiuni:

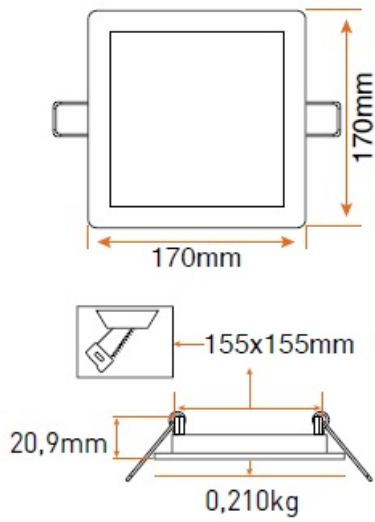

Pret: 78,42 LEI (TVA inclus)

Detalii online: <https://www.materialelectrice.ro/spot-incestrat-led-12w-lumina-calda-3000k-decupare-155x155mm-850lm>