



**COMTEC COMUTATOR CU CAME PORNIRE STEA-TRIUNGHI, 1-0-1, 4P/4ETAJE,
LW26, 20A**

Comutator cu came

Curent nominal: 20A;

Configuratie: 4 module, 4 etaje;

Tensiune nominala: 600V a.c.

Tensiune de impuls: 6kV

Curent termic nominal: 10A

Curent nominal: 3A (240V; 50HZ; AC15); 0.3A (240V c.c: DC13)

Sectiune conductor de racord: 1×0.5...1×2.5 mm (2×1.5mm)

Borna: clema cu surub

Domeniul de temperatura: – 25...+ 70 grade C

Grad de protectie: IP 42 (dupa montare)

Fiabilitate: 1x 1000000 cicluri de comutare

Grosime placa de montare: 6 mm max.

Diametru gaura de decupare: 22 mm

Schema contacte

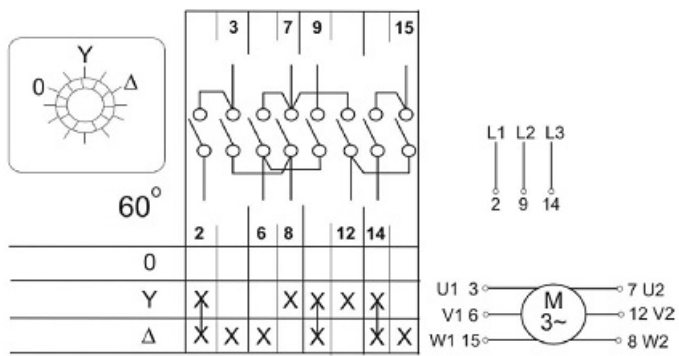

Dimensiuni

Dimensiuni comutatoare

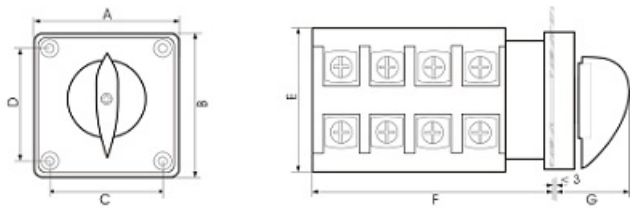

	A	B	C	D	E	F	G
Ith= 20 A	48	48	36	36	43	60	25
Ith= 25 A	48	48	36	36	45	71	25
Ith= 32 A	64	64	47	47	58	88	32
Ith= 63 A	65	65	47	47	66	115	38
Ith= 125 A	88	88	68	68	84	143	42
Ith= 160 A	88	88	68	68	88	165	42

Pret: 55,32 LEI (TVA inclus)

Detalii online: <https://www.materialelectrice.ro/comutator-cu-came-pornire-stea-triunghi-1-0-1-4p-4etaje-lw26-20a>